

P/N LEGEND

F0519 WR-SF-XP N L X XX X 00 R

① Series No.
 ② Connector type: WR=Right angle
 ③ Mounting type: SF=SMT with boss
 ④ No. of circuits
 ⑤ N=Halogen Free
 ⑥ Material: L=LCP
 ⑦ Color: N=Natural B=Black
 ⑧ Plating code for contacts:
 G1=Gold-flash; G2=Gold-plated 3U"
 T1=Matte Tin-plated
 ⑨ Plating code for solder tabs:
 G=Gold-flash; T=Matte Tin-plated
 ⑩ Option code: 00=Standard
 ⑪ Packing code:
 R=Tape & Reel(Without Cap or Mylar)

Circuit Dimensions				Circuit Dimensions			
No.	A	B	C	No.	A	B	C
05P	2.00	3.05	5.90	23P	11.00	12.05	14.90
06P	2.50	3.55	6.40	24P	11.50	12.55	15.40
07P	3.00	4.05	6.90	25P	12.00	13.05	15.90
08P	3.50	4.55	7.40	26P	12.50	13.55	16.40
09P	4.00	5.05	7.90	27P	13.00	14.05	16.90
10P	4.50	5.55	8.40	28P	13.50	14.55	17.40
11P	5.00	6.05	8.90	29P	14.00	15.05	17.90
12P	5.50	6.55	9.40	30P	14.50	15.55	18.40
13P	6.00	7.05	9.90	31P	15.00	16.05	18.90
14P	6.50	7.55	10.40	32P	15.50	16.55	19.40
15P	7.00	8.05	10.90	33P	16.00	17.05	19.90
16P	7.50	8.55	11.40	34P	16.50	17.55	20.40
17P	8.00	9.05	11.90	35P	17.00	18.05	20.90
18P	8.50	9.55	12.40	36P	17.50	18.55	21.40
19P	9.00	10.05	12.90	37P	18.00	19.05	21.90
20P	9.50	10.55	13.40	38P	18.50	19.55	22.40
21P	10.00	11.05	13.90	39P	19.00	20.05	22.90
22P	10.50	11.55	14.40	40P	19.50	20.55	23.40

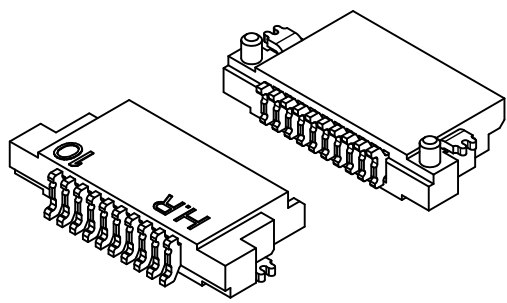
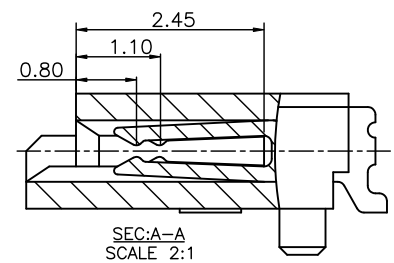
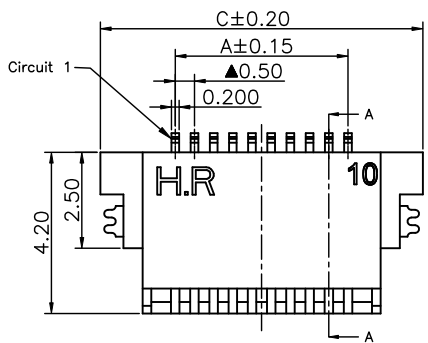

SPECIFICATIONS
 Current Rating: 0.5A AC,DC
 Voltage Rating: 50V AC,DC
 Temperature Range: -25°C ~ +85°C
 Contact Resistance: 30mΩ Max.
 Insulation Resistance: 500MΩ Min.
 Withstanding Voltage: 200V AC/minute

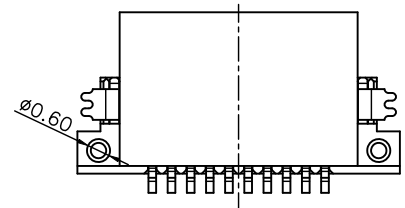
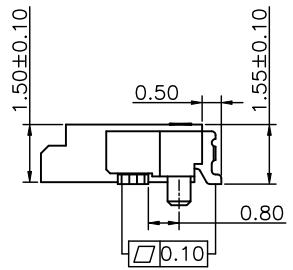
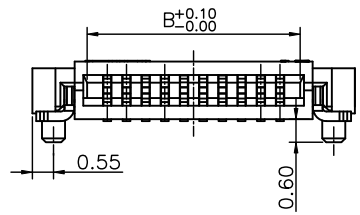

				 燦達電子工業股份有限公司 JOINT TECH ELECTRONIC IND. CO., LTD.			
UNIT		SCALE		SHEET		TITLE:	
mm		1 : 1		1 of 2		0.50mm PITCH FFC/FPC CONNECTOR 90° SMT TYPE, NON-ZIF	
DRAWN BY		APPROVED BY					
權生新		謝瑞清					
2013.01.29		2013.01.29					
GENERAL TOLERANCE				ANGLE±			
A2	EN1809140002	2018.09.14	徐富永	X.X±0.25			
A1	EN1405190005	2014.05.19	唐騰鳳	X.XX±0.15			
A0	NEW RELEASE	2013.01.29	權生新	X.XXX±0.05			
REV.	DESCRIPTION	DATE	NAME			DRAW NO. : F0519WR-SF-XPXXXXXXX	
						REV. A2	



05~27P Contacts

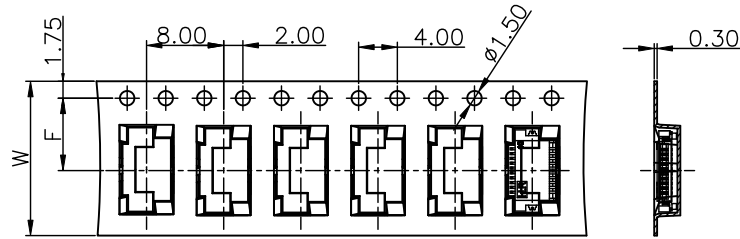

Unreeling direction



28~40P Contacts

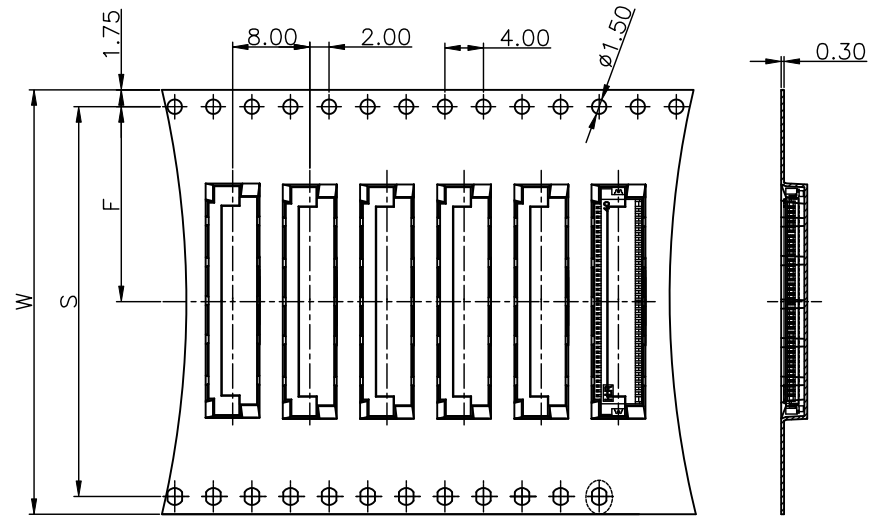

Unreeling direction

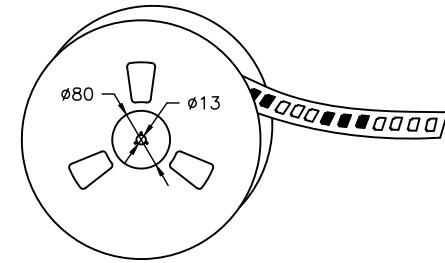
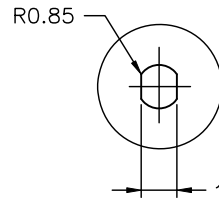
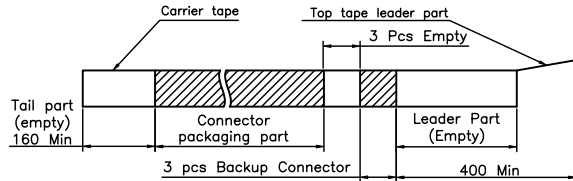

NOTE:

Material: Transparent
Anti-static Polystyrene.

Number of Contacts	W±0.3	F±0.1	S±0.1	Q'ty/Reel	Number of Contacts	W±0.3	F±0.1	S±0.1	Q'ty/Reel						
05P	16.00	7.50		3,400	23P	24.00	11.50		3,400						
06P				3,400	24P				3,400						
07P				3,400	25P				3,400						
08P				3,400	26P				3,400						
09P				3,400	27P				3,400						
10P				3,400	28P				3,400						
11P				3,400	29P				3,400						
12P				3,400	30P				3,400						
13P				24.00	11.50					3,400	31P	32.00	14.20	28.40	3,400
14P										3,400	32P				3,400
15P	3,400	33P	3,400												
16P	3,400	34P	3,400												
17P	3,400	35P	3,400												
18P	3,400	36P	3,400												
19P	3,400	37P	3,400												
20P	3,400	38P	3,400												
21P	3,400	39P	3,400												
22P	3,400	40P	3,400												

				燦達電子工業股份有限公司 JOINT TECH ELECTRONIC IND. CO., LTD.			
		UNIT	SCALE	SHEET		TITLE:	
		mm	1 : 1	2 of 2		0.50mm PITCH FFC/FPC	
		DRAWN BY		APPROVED BY		CONNECTOR, 90° SMT TYPE,	
		權生新		謝瑞清		ZIF, BOTTOM CONTACT STYLE,	
		2013.01.29		2013.01.29		TAPING SPEC.	
A2	EN1809140002	2018.09.14	徐富永	GENERAL TOLERANCE			
A1	EN1405190005	2014.05.19	唐騰鳳	X.X±0.25	ANGLE±		
A0	NEW RELEASE	2013.01.29	權生新	X.XX±0.15			
REV.	DESCRIPTION	DATE	NAME	X.XXX±0.05	DRAW NO. : F0519WR-SF-XPXXXXXXX		
						REV. A2	